

# DIESEL GENERATOR SET



| Service       |         | Standby | Prime       |
|---------------|---------|---------|-------------|
| Power         | kVA     | 1500    | 1400        |
| Frequency     | Hz      |         | 50          |
| Voltage       | V       |         | 230/400     |
| Phase         | Cos Phi |         | 3           |
| Fuel          |         |         | Diesel      |
| Control Panel |         |         | Datakom 500 |

ENMAKSAN has ISO 9001, ISO 14001 and OHSAS 18001 quality certifications.

ENMAKSAN gensets are compliant with EC mark which includes the following directives:

- 2006/42/CE Machinery safety.
- 2014/30/UE Electromagnetic compatibility.
- 2014/35/UE electrical equipment designed for use within certain voltage limits
- 2000/14/EC Sound Power level. Noise emissions outdoor equipment. (amended by 2005/88/EC)
- 97/68/EC Emissions of gaseous and particulate pollutants. (amended by 2002/88/EC & 2004/26/EC)
- EN 12100, EN 13857, EN 60204

Ambient conditions of reference according to ISO 8528-1:2005 normative: 1000 mbar, 25°C, 30% relative humidity.

G2 class load acceptance in accordance with ISO 8528-5:2013

## ENGINE

| Service                      | Specifications            |           |
|------------------------------|---------------------------|-----------|
| Engine Brand                 | CUMMINS                   |           |
| Engine Model                 | KTA50G8                   |           |
| Standby Power                | <i>kWm</i>                | 1397      |
| Prime Power                  | <i>kWm</i>                | 1168      |
| Fuel Type                    | Diesel                    |           |
| Number of Cylinders and Type | V-16                      |           |
| Bore x Stroke                | <i>mm</i>                 | 159 x 159 |
| Total Displacement           | <i>L</i>                  | 50,3      |
| Aspiration                   | Turbocharged, Aftercooled |           |
| Compression Ratio            | 14.9:1                    |           |
| Rated Speed                  | <i>rpm</i>                | 1500      |
| Injection Type and System    | Direct injection          |           |
| Governor System              | Electronics               |           |
| Operating Voltage            | <i>Vdc</i>                | 24        |
| Cooling System               | Water Cooled              |           |
| Air Filter Type              | Dry Type                  |           |

## ALTERNATOR

| Service              | Specifications |
|----------------------|----------------|
| No of Phases         | 3              |
| Power Factor         | 0,8            |
| No of Bearings       | Single         |
| No of Poles          | 4              |
| No of Leads          | 6-12           |
| Insulation Class     | H              |
| Degree of Protection | IP23           |
| Excitation System    | AVR            |

### OPTIONAL ALTERNATOR MODELS

|   |              |
|---|--------------|
|  maranello alternator | <b>M1500</b> |
|---|--------------|

### Standard Generator Features

- Heavy duty water cooled diesel engine and brushless alternator
- Solid steel base frame with minimum 8 hours base tank and anti-vibration mountings
- AMF Control panel with digital-automatic main control module
- 50C Tropical radiator
- Battery charge redressor. Lead acid battery
- Residential type silencer
- Flexible exhaust compensator
- Block water heater unit
- All rotating parts are covered by metal mesh against damages
- Engine and alternator manufacturer test reports (if provided )
- Factory load, performance and function tests
- User Manual, Electrical Drawing and Gurantee certificate

### Note

All data based on operation to ISO 3046/1, BS 5514 and DIN 6271 standard reference conditions.

### Prime Power (PRP)

According to ISO 8528-1:2005, Prime power is the maximum power which a generating set is capable of delivering continuously whilst supplying a variable electrical load when operated for an unlimited number of hours per year under the agreed operating conditions with the maintenance intervals and procedures being carried out as prescribed by the manufacturer. The permissible average power output (Ppp) over 24 h of operation shall not exceed 70 % of the PRP.

### Emergency Standby Power (ESP):

According to ISO 8528-1:2005, Emergency standby power is the maximum power available during a variable electrical power sequence, under the stated operating conditions, for which a generating set is capable of delivering in the event of a utility power outage or under test conditions for up to 200 h of operation per year with the maintenance intervals and procedures being carried out as prescribed by the manufacturers. The permissible average power output over 24 h of operation shall not exceed 70 % of the ESP.

## DIMENSIONS

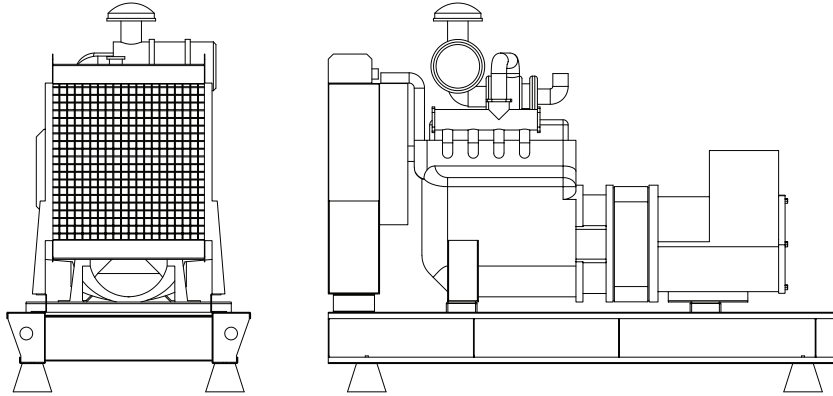

### OPEN TYPE

|                    |    |     |
|--------------------|----|-----|
| WxLxH              | mm | TBA |
| Weight             | kg | TBA |
| Fuel Tank Capacity | lt | TBA |

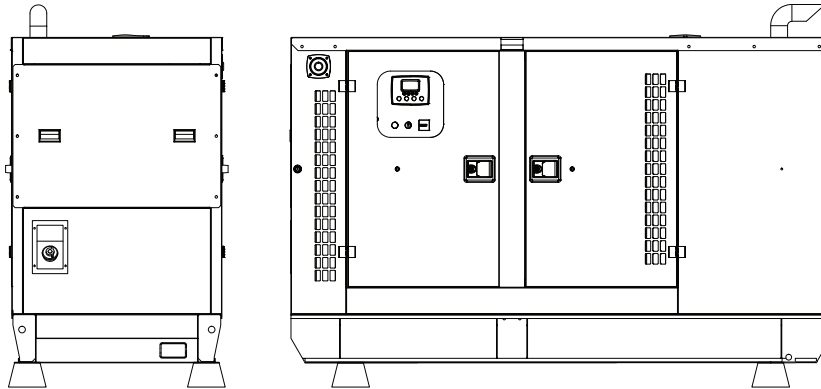

### CANOPIED

|                    |    |     |
|--------------------|----|-----|
| WxLxH              | mm | TBA |
| Weight             | kg | TBA |
| Fuel Tank Capacity | lt | TBA |

### Sound Proof Canopy Specifications

- Special design for minimizing acoustic level
- Galvanized steel construction further protected by polyester powder coat paint
- Black finish stainless steel locks and hinges
- Control panel viewing window in a lockable access door
- Emergency stop push button (red) mounted on enclosure exterior
- Lifting, drag and jacking points on base frame
- Radiator fill via removable, flush mounted rain cap fitted with compression seal

## OPTIONAL GENSET CONTROLLERS

Next generation single gen-set controllers for Stand-by and Prime power applications combining multi-functionality and wide communication with EFI engines.

Datakom SMART 200



Datakom D500



Datakom D500-GSM



EMKO Trans-AUTO



DEEPSEA 7320



ComAp AMF25



|  | Datakom SMART 200 | Datakom D500 | Datakom D500-GSM | Deepsea 6120 | Deepsea 7320 | ComAp AMF25 | EMKO Trans-AUTO |
|--|-------------------|--------------|------------------|--------------|--------------|-------------|-----------------|
| Automatic Mains Monitoring                     | ✓                 | ✓            | ✓                | ✓            | ✓            | ✓           | ✓               |
| Manuel Start                                   | ✓                 | ✓            | ✓                | ✓            | ✓            | ✓           | ✓               |
| Remote Start                                   | OPTIONAL          | OPTIONAL     | ✓                | <b>X</b>     | OPTIONAL     | OPTIONAL    | OPTIONAL        |
| Remote Monitoring With Sim Card                | <b>X</b>          | OPTIONAL     | OPTIONAL         | OPTIONAL     | OPTIONAL     | OPTIONAL    | OPTIONAL        |
| 1 Aditonal Option (Horn, Oil-Fuel Heater Etc.) | ✓                 | ✓            | ✓                | ✓            | ✓            | ✓           | ✓               |
| Light Warning And Mimic Diagram                | ✓                 | ✓            | ✓                | ✓            | ✓            | ✓           | ✓               |
| Battery Charger                                | ✓                 | ✓            | ✓                | ✓            | ✓            | ✓           | ✓               |
| Rs-485 Communication                           | OPTIONAL          | ✓            | ✓                | <b>X</b>     | ✓            | OPTIONAL    | ✓               |
| Ethernet (Tcp-Ip) Communication                | <b>X</b>          | ✓            | ✓                | <b>X</b>     | OPTIONAL     | OPTIONAL    | OPTIONAL        |

## GENSET CONTROLLERS FOR SYNCHRONIZATION SYSTEMS

Next generation synchronizing genset controller capable of every communication and functionality.

Datakom D500 MK2



Datakom D700



DEEPSEA 8610



DEEPSEA 8620



DEEPSEA 8660



ComAp IntelliCompact NT SPTM



ComAp IntelliGen BaseBox



ComAp IntelliGen 200

