

DIESEL GENERATOR SET



Service		Standby	Prime
Power	kVA	440	400
Frequency	Hz		50
Voltage	V		230/400
Phase	Cos Phi		3
Fuel			Diesel
Control Panel			Datakom 500

ENMAKSAN has ISO 9001, ISO 14001 and OHSAS 18001 quality certifications.

ENMAKSAN gensets are compliant with EC mark which includes the following directives:

- 2006/42/CE Machinery safety.
- 2014/30/UE Electromagnetic compatibility.
- 2014/35/UE electrical equipment designed for use within certain voltage limits
- 2000/14/EC Sound Power level. Noise emissions outdoor equipment. (amended by 2005/88/EC)
- 97/68/EC Emissions of gaseous and particulate pollutants. (amended by 2002/88/EC & 2004/26/EC)
- EN 12100, EN 13857, EN 60204

Ambient conditions of reference according to ISO 8528-1:2005 normative: 1000 mbar, 25°C, 30% relative humidity.

G2 class load acceptance in accordance with ISO 8528-5:2013

ENGINE

Service	Specifications	
Engine Brand	CUMMINS	
Engine Model	QSX15G4	
Standby Power	<i>kWm</i>	385
Prime Power	<i>kWm</i>	348
Fuel Type	Diesel	
Number of Cylinders and Type	6- In Line	
Bore x Stroke	<i>mm</i>	137 × 169
Total Displacement	<i>L</i>	15
Aspiration	Turbocharged,	
Compression Ratio	-	
Rated Speed	<i>rpm</i>	1500
Injection Type and System	Direct injection	
Governor System	Electronics	
Operating Voltage	<i>Vdc</i>	24
Cooling System	Water Cooled	
Air Filter Type	Dry Type	

ALTERNATOR

Service	Specifications	
No of Phases	3	
Power Factor	0,8	
No of Bearings	Single	
No of Poles	4	
No of Leads	6-12	
Insulation Class	H	
Degree of Protection	IP23	
Excitation System	AVR	

OPTIONAL ALTERNATOR MODELS

 maranello alternator	M440
---	-------------

Standard Generator Features

- Heavy duty water cooled diesel engine and brushless alternator
- Solid steel base frame with minimum 8 hours base tank and anti-vibration mountings
- AMF Control panel with digital-automatic main control module
- 50C Tropical radiator
- Battery charge redressor. Lead acid battery
- Residential type silencer
- Flexible exhaust compensator
- Block water heater unit
- All rotating parts are covered by metal mesh against damages
- Engine and alternator manufacturer test reports (if provided)
- Factory load, performance and function tests
- User Manual, Electrical Drawing and Gurantee certificate

Note

All data based on operation to ISO 3046/1, BS 5514 and DIN 6271 standard reference conditions.

Prime Power (PRP)

According to ISO 8528-1:2005, Prime power is the maximum power which a generating set is capable of delivering continuously whilst supplying a variable electrical load when operated for an unlimited number of hours per year under the agreed operating conditions with the maintenance intervals and procedures being carried out as prescribed by the manufacturer. The permissible average power output (Ppp) over 24 h of operation shall not exceed 70 % of the PRP.

Emergency Standby Power (ESP):

According to ISO 8528-1:2005, Emergency standby power is the maximum power available during a variable electrical power sequence, under the stated operating conditions, for which a generating set is capable of delivering in the event of a utility power outage or under test conditions for up to 200 h of operation per year with the maintenance intervals and procedures being carried out as prescribed by the manufacturers. The permissible average power output over 24 h of operation shall not exceed 70 % of the ESP.

DIMENSIONS

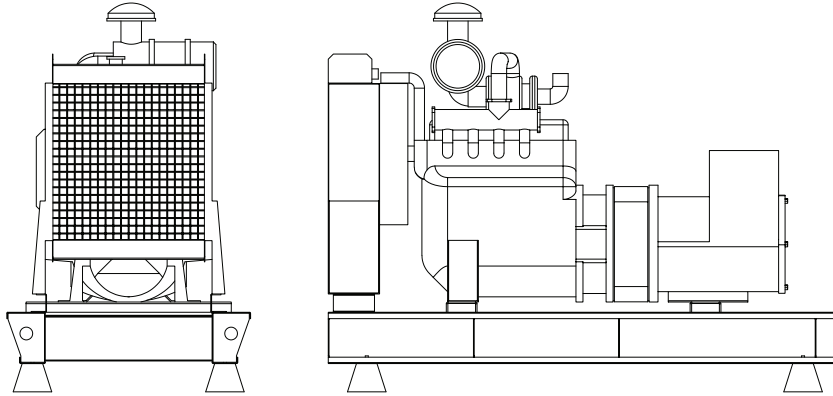

OPEN TYPE

WxLxH	mm	TBA
Weight	kg	TBA
Fuel Tank Capacity	lt	TBA

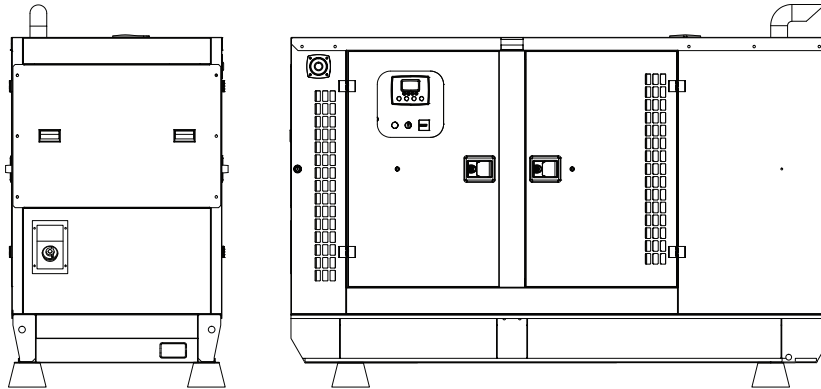

CANOPIED

WxLxH	mm	TBA
Weight	kg	TBA
Fuel Tank Capacity	lt	TBA

Sound Proof Canopy Specifications

- Special design for minimizing acoustic level
- Galvanized steel construction further protected by polyester powder coat paint
- Black finish stainless steel locks and hinges
- Control panel viewing window in a lockable access door
- Emergency stop push button (red) mounted on enclosure exterior
- Lifting, drag and jacking points on base frame
- Radiator fill via removable, flush mounted rain cap fitted with compression seal

OPTIONAL GENSET CONTROLLERS

Next generation single gen-set controllers for Stand-by and Prime power applications combining multi-functionality and wide communication with EFI engines.

Datakom SMART 200



Datakom D500



Datakom D500-GSM



EMKO Trans-AUTO



DEEPSEA 7320



ComAp AMF25



	Datakom SMART 200	Datakom D500	Datakom D500-GSM	Deepsea 6120	Deepsea 7320	ComAp AMF25	EMKO Trans-AUTO
Automatic Mains Monitoring	✓	✓	✓	✓	✓	✓	✓
Manuel Start	✓	✓	✓	✓	✓	✓	✓
Remote Start	OPTIONAL	OPTIONAL	✓	X	OPTIONAL	OPTIONAL	OPTIONAL
Remote Monitoring With Sim Card	X	OPTIONAL	OPTIONAL	OPTIONAL	OPTIONAL	OPTIONAL	OPTIONAL
1 Aditonal Option (Horn, Oil-Fuel Heater Etc.)	✓	✓	✓	✓	✓	✓	✓
Light Warning And Mimic Diagram	✓	✓	✓	✓	✓	✓	✓
Battery Charger	✓	✓	✓	✓	✓	✓	✓
Rs-485 Communication	OPTIONAL	✓	✓	X	✓	OPTIONAL	✓
Ethernet (Tcp-Ip) Communication	X	✓	✓	X	OPTIONAL	OPTIONAL	OPTIONAL

GENSET CONTROLLERS FOR SYNCHRONIZATION SYSTEMS

Next generation synchronizing genset controller capable of every communication and functionality.

Datakom D500 MK2



Datakom D700



DEEPSEA 8610



DEEPSEA 8620



DEEPSEA 8660



ComAp IntelliCompact NT SPTM



ComAp IntelliGen BaseBox



ComAp IntelliGen 200

